

# A journey to the hardware world

*A software engineer retrospective*

2023-02-04

Mathieu Othacehe <[othacehe@gnu.org](mailto:othacehe@gnu.org)>

C

Λ

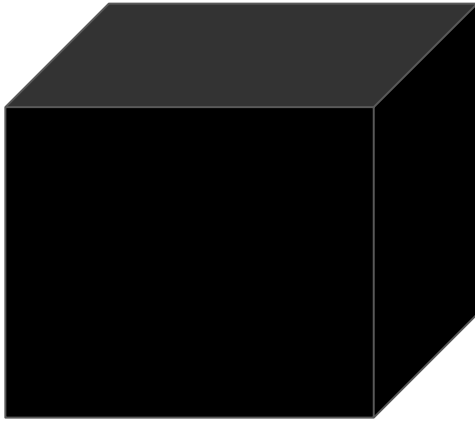

# Hardware repair and microsoldering

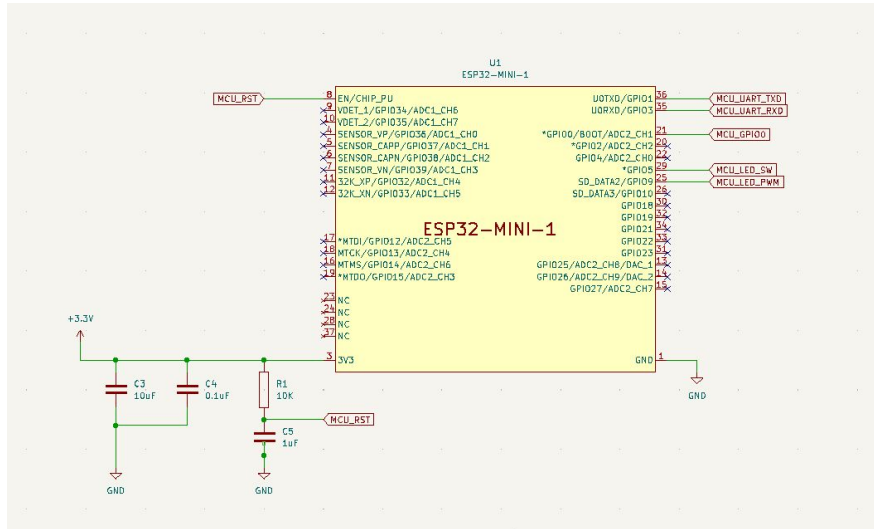

# Schematics



IC



Buy a few tools





Microscope

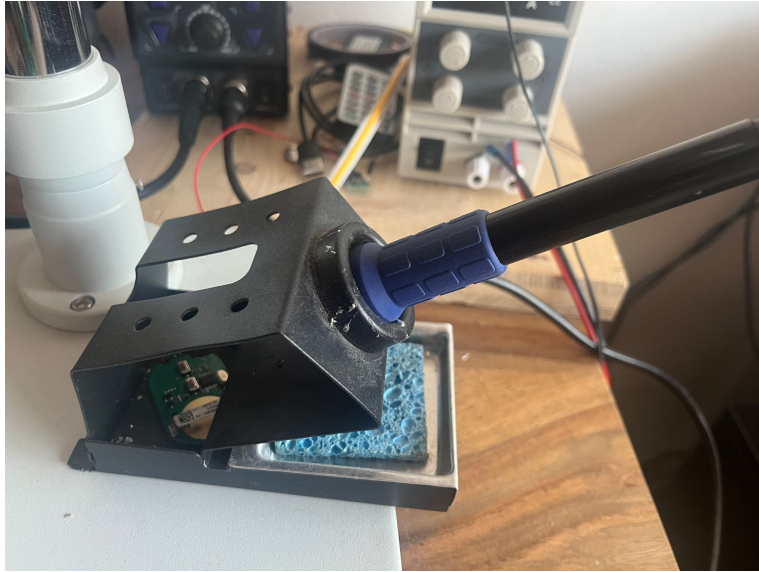

Soldering iron



Hot air station



Generator



Oscilloscope

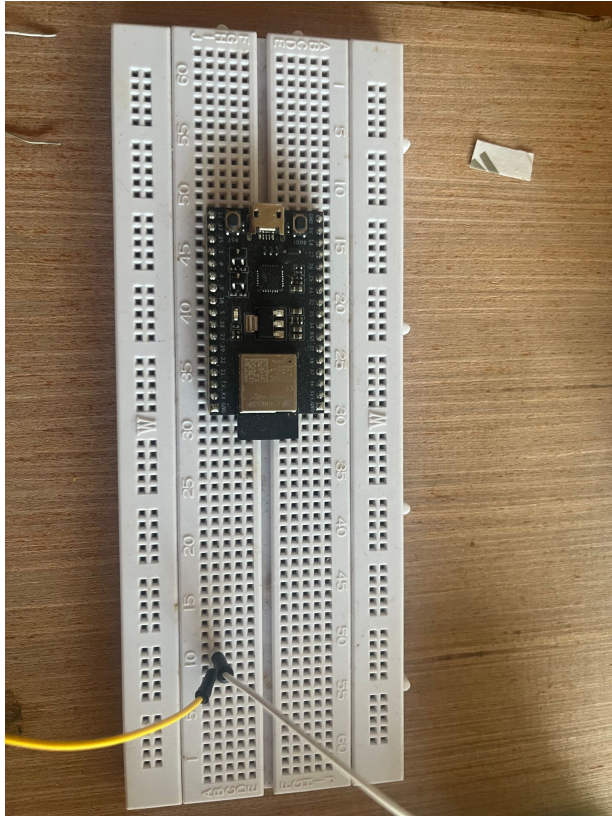

Breadboard



R, C, L



Multimeter





Flux



Solder wick



Tweezers

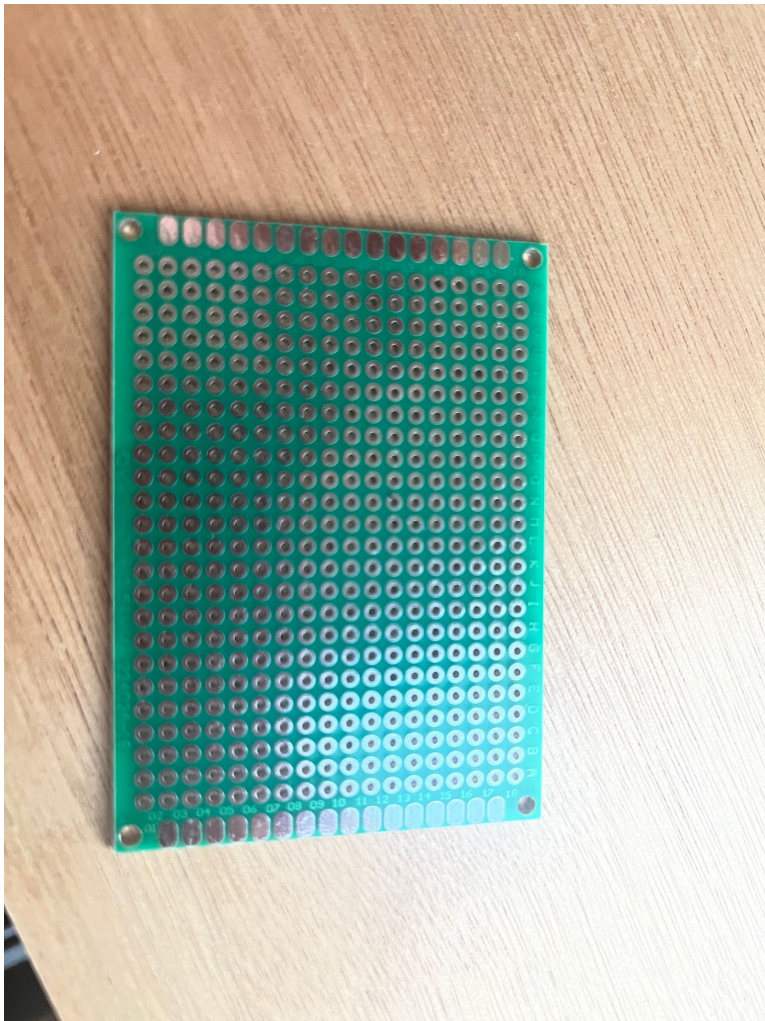

Perfboard



Wires



RLC meter

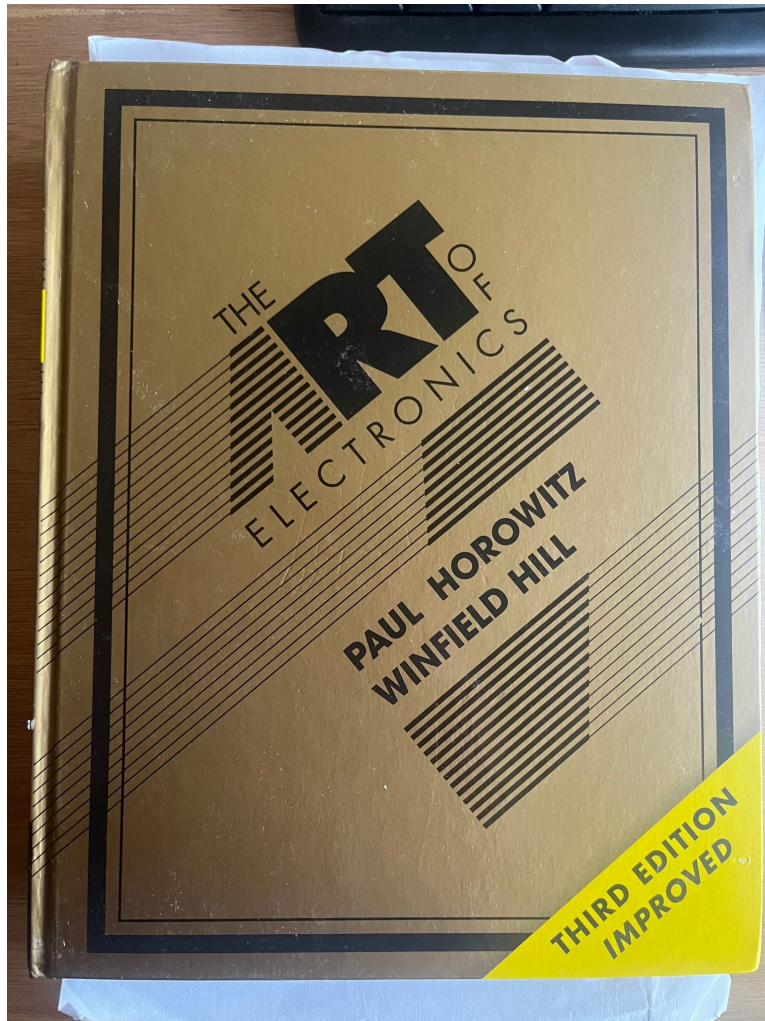

The art of electronics

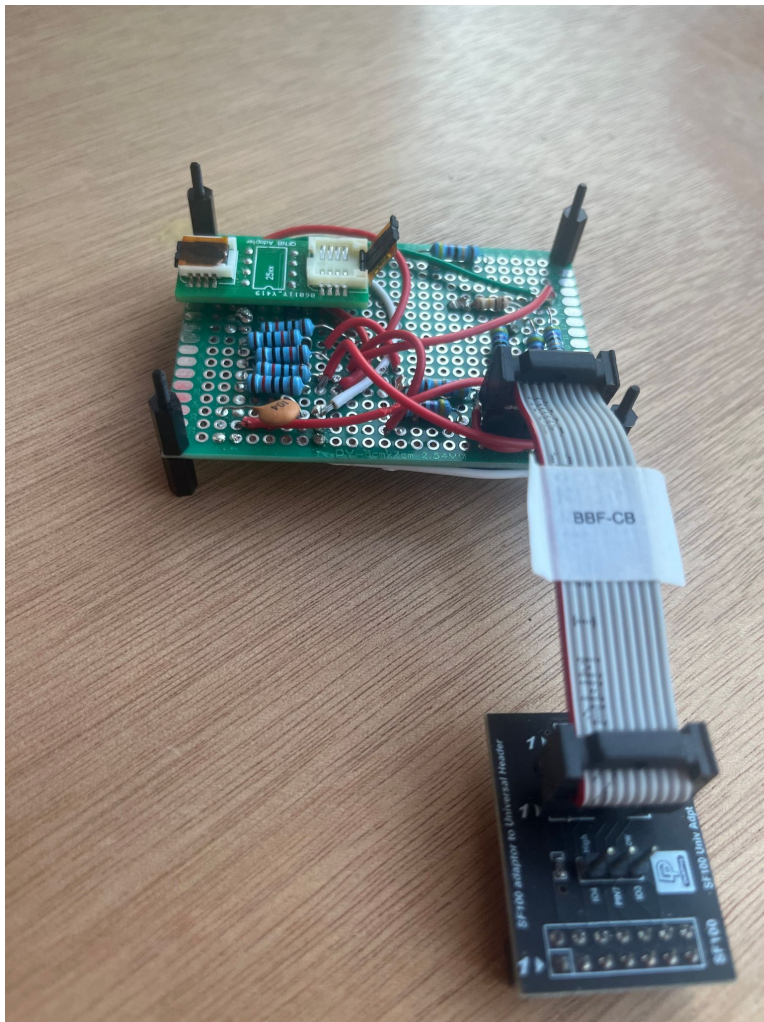

Flash memory programming device



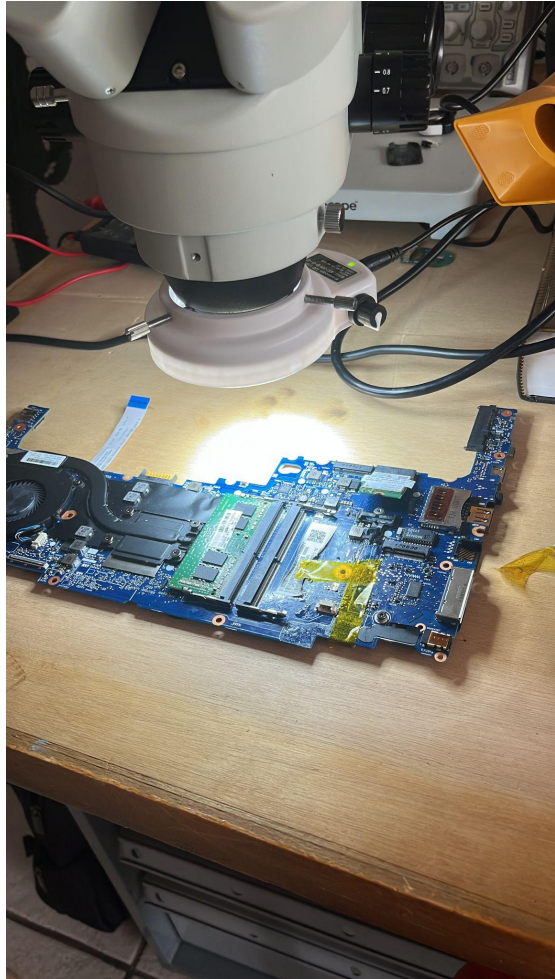

Few repairs

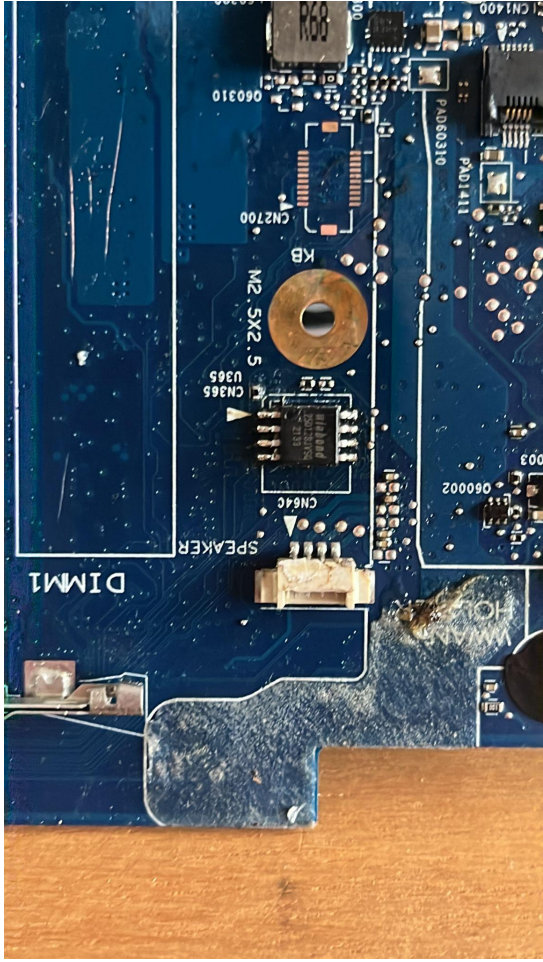

Hack a BIOS

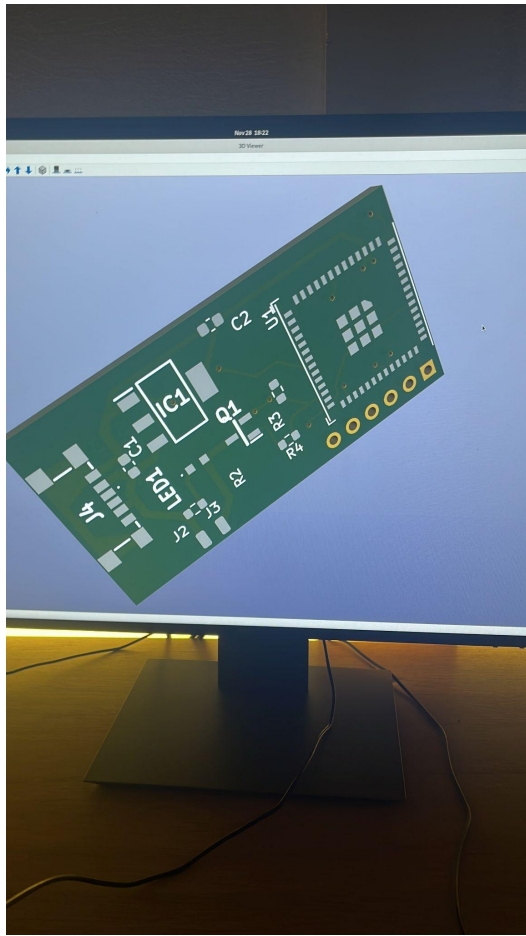

Kicad / LibreCAD

That's it